

**EQJW246F003**

P100020315

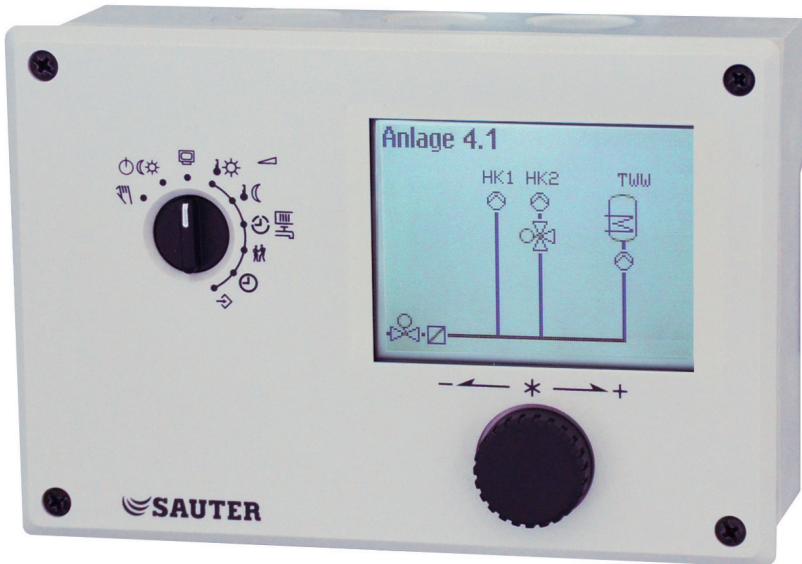

**Heating and District Heating Controller**  
with graphics display

Firmwareversion 3.02.01



## Note on these mounting and operating instructions

These mounting and operating instructions assist you in mounting and operating the device safely. The instructions are binding for handling SAUTER devices.

**A manual with further information can be found at [www.sauter-controls.com](http://www.sauter-controls.com)**

→ For the safe and proper use of these instructions, read them carefully and keep them for later reference.

### Definition of signal words

#### **DANGER**

*Hazardous situations which, if not avoided, will result in death or serious injury*

#### **WARNING**

*Hazardous situations which, if not avoided, could result in death or serious injury*

#### **NOTICE**

*Property damage message or malfunction*

#### **Note**

*Additional information*

#### **Tip**

*Recommended action*

<b>1</b>	<b>Liability .....</b>	<b>4</b>
<b>2</b>	<b>Safety instructions .....</b>	<b>4</b>
<b>3</b>	<b>Structure and mode of action .....</b>	<b>5</b>
<b>4</b>	<b>Dimensions .....</b>	<b>6</b>
<b>5</b>	<b>Installation .....</b>	<b>7</b>
<b>6</b>	<b>Electrical connection .....</b>	<b>8</b>
<b>7</b>	<b>Control elements .....</b>	<b>12</b>
<b>8</b>	<b>Operation .....</b>	<b>13</b>
8.1	Selecting the operating mode .....	13
8.2	Schedules .....	15
8.2.1	Setting the time and date .....	15
8.2.2	Setting the times-of-use.....	16
8.3	Entering day and night set points .....	19
8.4	Reset to default settings.....	21
8.5	Reading information.....	22
8.5.1	Adapting the Trend-Viewer .....	26
8.6	Operating the controller in manual mode.....	28
<b>9</b>	<b>Error list .....</b>	<b>29</b>
<b>10</b>	<b>Technical data .....</b>	<b>30</b>

## **Liability**

### **1 Liability**

We are constantly developing our products and therefore, reserve the right to change the product at any time without notice.

*We assume no liability for the correctness or completeness of this quick guide. No liability is accepted for the purchaser being able to use the products for a specific purpose.*

*Claims by the purchaser, in particular claims for damages including loss of profit or other financial losses, are excluded. This does not apply if the cause of the damage is based on intent or gross negligence. If an essential contractual obligation is negligently breached, our liability shall be limited to the foreseeable damage.*

### **2 Safety instructions**

*The device must be mounted, started up or operated only by trained and experienced personnel familiar with the product. Proper shipping and storage are assumed.*

*The device has been designed for use in electrical power systems. For wiring and maintenance, you are required to observe the relevant safety regulations.*

*This quick guide is intended to provide the necessary information for operating the device.*

### **3 Structure and mode of action**

The EQJW246F003 heating and district heating controller is used to control up to three control circuits.

- Control of a primary heat exchanger or boiler with up to two mixed and one unmixed heating circuit (each weather-compensated) and control of DHW heating on the secondary side
- Weather-compensated buffer cylinder control with up to two mixed heating circuits and fresh water module
- Control of two weather-compensated heating circuits and a DHW heating system with three valves on the primary side
- Control of three weather-compensated heating circuits with three valves on the primary side
- Applications with up to six control loops possible via optional extension modules (0440210014) (coupled via device bus)
- Systems with a larger number of control loops can be realised by interconnecting controllers via a device bus.

The EQJW246F003 heating and district heating controller is customised to the specific system by setting a system code number. Additional sensors and/or functions not included in the basic system configuration are then selected by defining function blocks. The corresponding levels are accessed by selecting the switch position and then entering the code number. For the specialist personnel, configuration levels for defining function blocks are labelled „CO“ and parameter levels are labelled „PA“. Data is entered and queried on the heating and district heating controller using a rotary and push button. It is supported by symbol overlays and plain text on the LC display. The rotary switch is used to set the operating modes and the main parameters of the individual circuits.

#### **M-Bus interface**

Up to three meters in accordance with EN 1434-3 can be connected for data transmission. In addition, heat meters for volume flow and/or output limitation are available for each control circuit. For control circuit HK1, different limit values can be set for the different operating states „heating control only“, „heating control with simultaneous DHW heating“ and „DHW heating only“. Weather-compensated volume flow or output limitation can also be realised.

## Dimensions

### 4 Dimensions

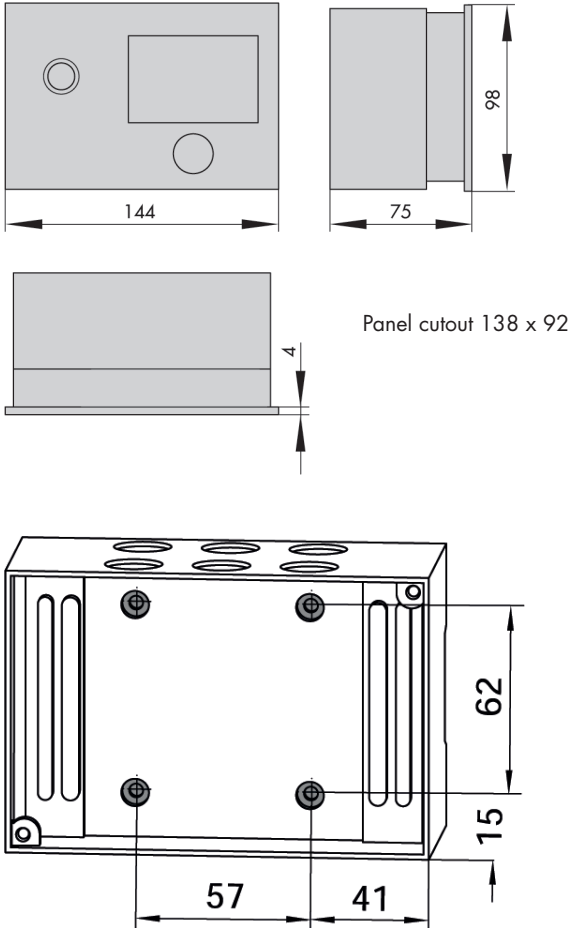

## 5 Installation

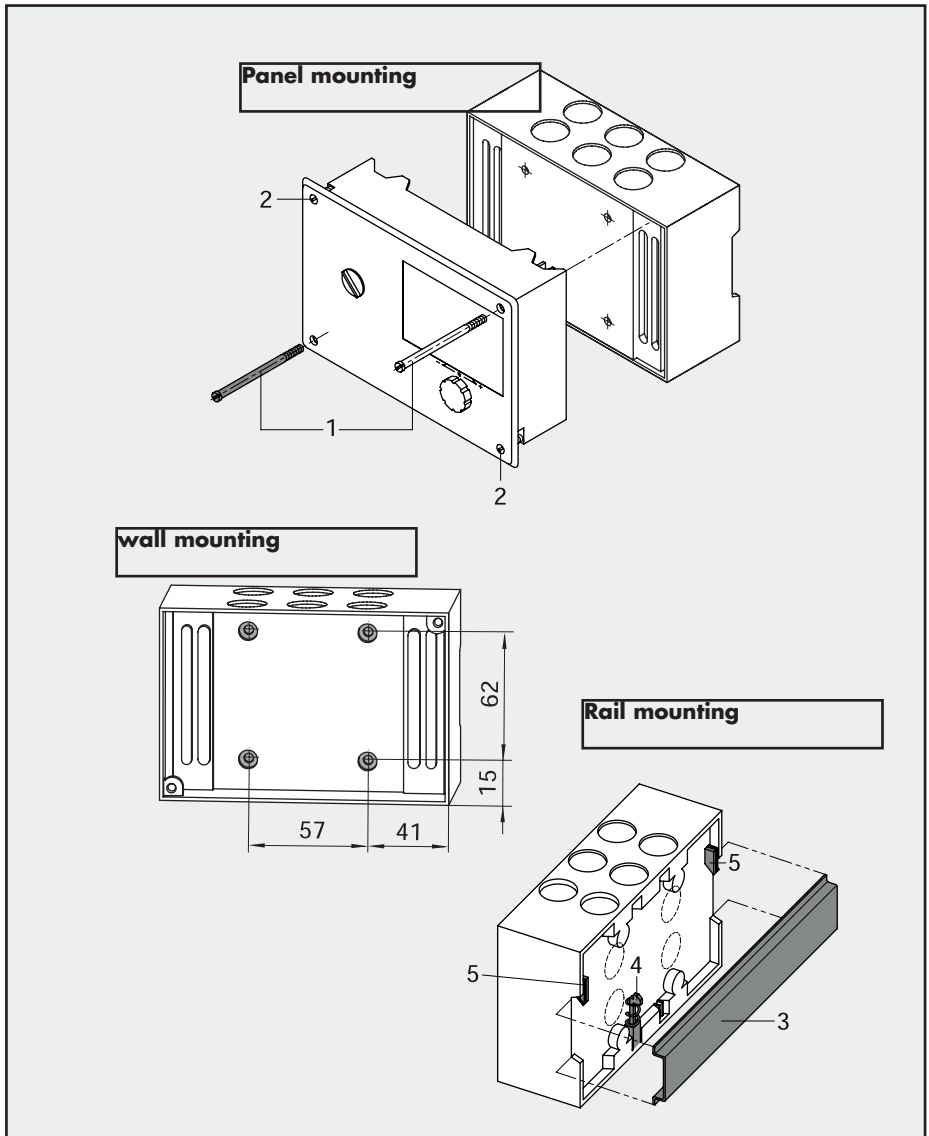

# 6 Electrical connection

---

### **⚠ DANGER**

#### ***Danger to life from electric shock!***

- When wiring and connecting the heating and district heating controller, the VDE regulations and the regulations of the local energy supply companies must always be observed. This work must therefore be carried out by a specialist!
  - Terminals 33, 39, 42 and 45 allow the targeted integration of safety devices with a direct effect on the individual motor drives and pumps. If this is not required, connect a jumper from terminal 31 to terminals 33, 39, 42 and 45.
  - Do not connect cables carrying extra-low voltage in accordance with VDE 0100 directly.
  - De-energise the heating and district heating controller before working on the connections.
- 

#### **Instructions for laying the electrical cables**

- Lay 230 V supply lines and signalling lines separately and at a distance.
- To increase interference immunity, maintain a minimum distance of 10 cm between the cables. This spatial separation must also be observed within an electrical enclosure.
- Also lay the cables for digital signals (bus cables) and analogue signal cables (sensor cables, analogue outputs) separately and at a distance.
- Use shielded cables for the analogue signals in systems with a high electromagnetic interference level.
- Earth the shield on one side at the inlet or outlet of the switch cabinet, making contact over a large area. Connect the central earthing point to the PE protective conductor by the shortest route (conductor cross-section at least 10 mm<sup>2</sup>).
- Equip inductivities in the switch cabinet, e.g. contactor coils, with suitable interference suppression circuits (RC elements).
- Shield switch cabinet parts with high field strengths, e.g. transformers or frequency converters, with separators that have a good connection to the PE protective conductor.
- Use cables with wire cross-sections according to Table 5-1 for the terminal connections.



### Overvoltage protection

- If signalling cables are laid outside buildings or over long distances, take suitable overvoltage protection measures. Such measures are essential for bus cables.
- The shielding of signalling cables that are laid outside buildings must be current-carrying and earthed on both sides.
- The surge arresters must be installed at the entry to the switch cabinet.

### Connection of the heating and district heating controller

- ➔ If the controller housing and rear part of the housing are not already separated: To connect the cables, open the housing by loosening the front screws at the bottom left and top right.
- ➔ Break through the openings marked for the cable entry at the top, bottom or rear of the rear part of the housing and fit the enclosed grommets or suitable screw connections.
- ➔ For wall mounting: Before inserting the cables into the base, support them with suitable measures, e.g. a cable duct, so that there is no strain or bending on the cables.

### Connecting the drives

- 0-bis-10-V-control output:  
Use cables with a wire cross-section of at least 0.5 mm<sup>2</sup>.
- Three-point/two-point control outputs:  
Run cables as damp-proof cables with a core cross-section of at least 1.5 mm<sup>2</sup> to the terminals of the controller output. It is advisable to check the running direction during commissioning.

### Connecting the pumps

Route all cables with a core cross-section of at least 1.5 mm<sup>2</sup> to the terminals of the heating and district heating controller in accordance with the wiring diagram.

---

#### **i Note**

The motor drives and pumps are not automatically supplied with power by the heating and district heating controller. They can be connected to an external power supply via terminals 33, 39, 42 and 45. If the electrical supply is to be internal, a jumper must be connected from terminal 31 to terminals 33, 39, 42 and 45.

---

# Electrical connection



Bild 1: Connection of SAUTER EQJW246F003 Controller with standard base

### Legend to picture 1:

AA	Analog output	PWM	Puls width modulation	SLP	Storage tank charging pump
AE	Analog input	RF	Room sensor	UP	Circulation pump
AF	Outdoor sensor	RK	Heating circuit	VF	Flow sensor
BA	Binary output	RüF	Return flow sensor	ZP	Circulation pump
BE	Binary input	SF	Storage sensor		
FG	Remote sensor				

## Operating controls

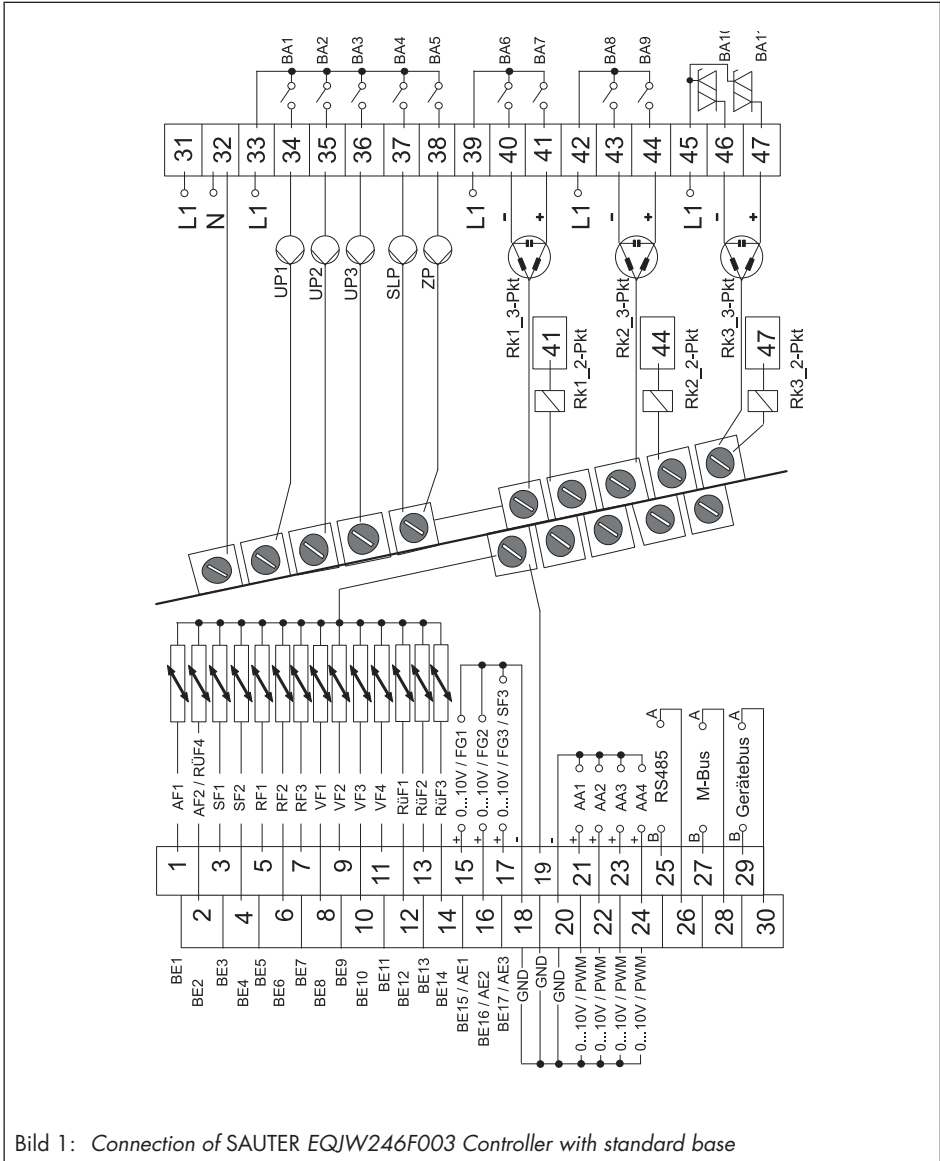
# 7 Operating controls

The heating controller is operated on site using the operating controls on the front. They are located in the front panel of the controller.

### Rotary pushbutton

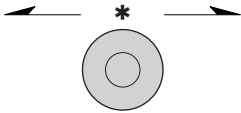



- Turn [↻]:  
Select readings, parameters and function blocks
- Press [\*]:  
Confirm adjusted selection or setting



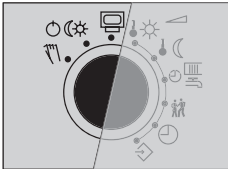

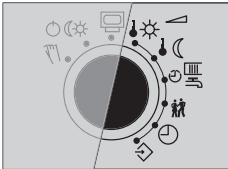

### Rotary switch

The rotary switch is used to set the operating mode and the relevant parameters for each control circuit.



-  Operating level
-  Operating modes
-  Manual level



-  Day set point (rated room temperature)
-  Night set point (reduced room temperature)
-  Times-of-use for heating/DHW
-  Special time-of-use
-  Time/date
-  Settings

## 8 Operation

### 8.1 Selecting the operating mode

The controller can be operated in the following modes:

**Day mode (rated operation):** regardless of the programmed times-of-use and summer mode, the set points relevant to rated operation are used by the controller. Icon: ✱✱

**Night mode (reduced operation):** regardless of the programmed times-of-use, the set points relevant to reduced operation are used by the controller. Icon: ) )

**Control operation deactivated:** regardless of the programmed times-of-use, control operation of the heating circuits and DHW heating remains deactivated. The frost protection is activated, if need be. Icon: ☺☺

Icons when the frost protection is activated: HC ☺ ) , DHW ☺ ✱

**Automatic mode:** During the programmed times-of-use, the controller works in day mode. Outside these times-of-use, the controller is in night mode, unless control operation is deactivated depending on the outdoor temperature. The controller switches automatically between both operating modes. Icon within the times-of-use: ☺✱, icon outside the times-of-use: ☺ )

**Manual mode:** valves and pumps can be controlled manually. For further details, see section 8.6.

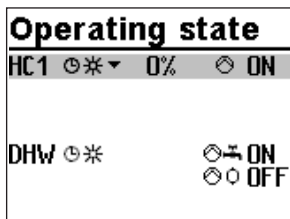

Turn the rotary switch to ☺✱ (operating modes). The operating states of all system control circuits are displayed:

- Heating circuit HC1
- Heating circuit HC2
- Heating circuit HC3
- Heating circuit HC11
- Heating circuit HC12
- Heating circuit HC13
- DHW heating

➔ Only those control circuits are available for selection which can be controlled by the selected system.

☺ Select the control circuit.

## Operation

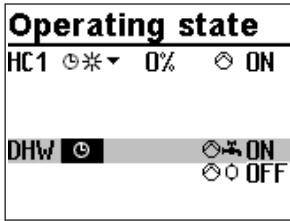

\* Activate editing mode for the control circuit. The operating mode is shown inverted on the display.

② Select the operating mode:

- ⏻ Automatic mode
- ⌘ Day mode
- 🌙 Night mode
- 🔌 System deactivated

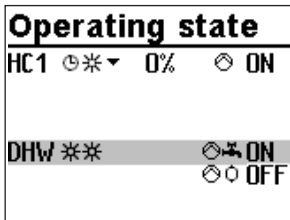

\* Confirm the operating mode.

The controller is usually in automatic mode.

## 8.2 Schedules

The controller operates according to the schedules in automatic mode.

### 8.2.1 Setting the time and date

The current time and date need to be set immediately after start-up and after a power failure lasting more than 24 hours. This is the case when the time blinks on the display.

Time/date	
Time	08:23
Date (dd.mm.)	21.01.
Year	2015
Auto summertime	ON

Turn the rotary switch to ⌚ (time/date). The current time is selected (gray background).

Time/date	
Time	08:23
Date (dd.mm.)	21.01.
Year	2015
Auto summertime	ON

\* Activate editing mode for the time. The time reading is inverted.

↻ Change the time.

\* Confirm the time setting.

Time/date	
Time	08:44
Date (dd.mm.)	21.01.
Year	2015
Auto summertime	ON

↻ Select 'Date' (dd.mm) [↻].

Time/date	
Time	08:44
Date (dd.mm.)	21.01.
Year	2015
Auto summertime	ON

\* Activate editing mode for the date. The date reading is inverted.

↻ Change date (day.month).

\* Confirm the date setting.

Time/date	
Time	08:45
Date (dd.mm.)	05.02.
Year	2010
Auto summertime	ON

↻ Select 'Year'.

Time/date	
Time	08:45
Date (dd.mm.)	05.02.
Year	2010
Auto summertime	ON

\* Activate editing mode for the year. The year reading is inverted.

↻ Change the year.

\* Confirm the year setting.

Deactivate or activate the automatic summer/standard time switchover as required.

## Operation

Time/date	
Time	08:45
Date (dd.mm.)	05.02.
Year	2015
Auto summertime	ON

⌚ Select 'Auto summertime'.

Time/date	
Time	08:45
Date (dd.mm.)	05.02.
Year	2015
Auto summertime	ON

\* Activate the editing mode for automatic summer/standard time switchover. The current setting is shown inverted on the display:

ON = Summer/standard time switchover active

OFF = Summer/standard time switchover not active

⌚ Deactivate or activate the automatic summer/standard time switchover.

\* Confirm deactivation/activation.

Turn the rotary switch back to  (operating level).

### **i** Note

*The correct time is guaranteed after a power failure of 24 hours. Normally, the correct time is still retained at least 48 hours after a power failure.*

## 8.2.2 Setting the times-of-use

Three times-of-use can be set for each day of the week.

Parameters	WE	Value range
	HC1, HC2, HC3, DHW, CP HC11, HC12, HC13	
Start first time-of-use	06:00	00:00
Stop first time-of-use	22:00	24:00
Start second time-of-use	--	--
Stop second time-of-use	--	--
Start third time-of-use	--	--
Stop third time-of-use	--	--



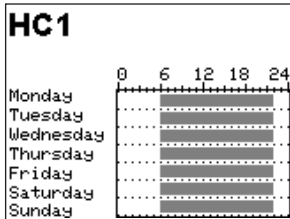

Turn the rotary switch to  $\text{Ⓢ}$  (times-of-use). The first control circuit is displayed together with its programmed times-of-use.

↻ Program the times-of-use of another control circuit, if required:

- Heating circuit HC2
- Heating circuit HC3
- Heating circuit HC11
- Heating circuit HC12
- Heating circuit HC13
- DHW heating
- Circulation pump (DHW) CP

➔ Only those control circuits are available for selection which can be controlled by the selected system.

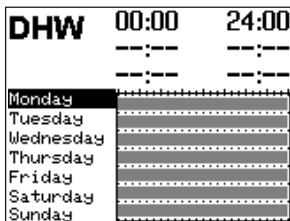

\* Activate editing mode for the control circuit. The times-of-use for Monday are displayed.

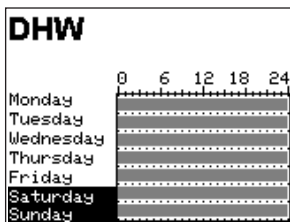

↻ Select period/day for which the times-of-use are to be valid. The times-of-use can be programmed for individual days or for a block of days, e.g. Monday to Friday, Saturday and Sunday or Monday to Sunday. The selected days are shown inverted on the display.

## Operation

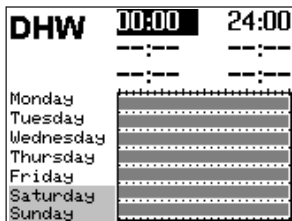

- \* Activate editing mode for the period/day.  
The start time of the first time-of-use period can now be edited (inverted reading).

⏪ Change start time.  
(in steps of 15 minutes)

- \* Confirm the start time.  
The stop time of the first time-of-use period can now be edited.

⏪ End stop time.  
(in steps of 15 minutes)

- \* Confirm the stop time.  
The start time of the second time-of-use period can now be edited.

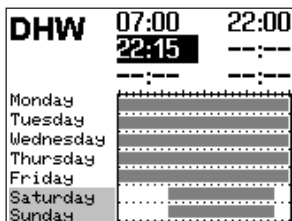

To set the second and third times-of-use periods, repeat steps with gray background. If no further times-of-use are to be programmed for the selected time period/day, exit the menu by confirming the indicated start time twice (2x \*).

Proceed in the same manner to program further periods/days.

### After setting all times-of-use:

- ⏪ Select 'Back'.
- \* Exit the times-of-use setting.

Turn the rotary switch back to  (operating level).

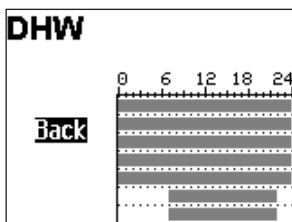

### 8.3 Entering day and night set points

The day set points apply during day mode (rated operation) and during times-of-use programmed for automatic mode.

The night set points apply during night mode (reduced operation) and outside the times-of-use programmed for automatic mode.

The desired room temperature for the day and night set points can be programmed.

#### Switch position ↓☼

Parameters	WE	Value range
HC1 room temperature	20.0 °C	0.0 to 40.0 °C
HC2 room temperature	20.0 °C	0.0 to 40.0 °C
HC3 room temperature	20.0 °C	0.0 to 40.0 °C
HC11 room temperature	20.0 °C	0.0 to 40.0 °C
HC12 room temperature	20.0 °C	0.0 to 40.0 °C
HC13 room temperature	20.0 °C	0.0 to 40.0 °C
DHW temperature	60.0 °C	Min. to max. DHW temperature
HC1 OT deactivation value	22.0 °C	0.0 to 50.0 °C
HC2 OT deactivation value	22.0 °C	0.0 to 50.0 °C
HC3 OT deactivation value	22.0 °C	0.0 to 50.0 °C
HC11 OT deactivation value	22.0 °C	0.0 to 50.0 °C
HC12 OT deactivation value	22.0 °C	0.0 to 50.0 °C
HC13 OT deactivation value	22.0 °C	0.0 to 50.0 °C

#### Switch position ↓☾

Parameters	WE	Value range
HC1 room temperature	15.0 °C	0.0 to 40.0 °C
HC2 room temperature	15.0 °C	0.0 to 40.0 °C
HC3 room temperature	15.0 °C	0.0 to 40.0 °C
HC11 room temperature	15.0 °C	0.0 to 40.0 °C
HC12 room temperature	15.0 °C	0.0 to 40.0 °C
HC13 room temperature	15.0 °C	0.0 to 40.0 °C
DHW temperature	40.0 °C	Min. to max. DHW temperature

## Operation

### Switch position 3((

Parameters	WE	Value range
HC1 OT deactivation value	15.0 °C	-50.0 to 50.0 °C
HC2 OT deactivation value	15.0 °C	-50.0 to 50.0 °C
HC3 OT deactivation value	15.0 °C	-50.0 to 50.0 °C
HC11 OT deactivation value	15.0 °C	-50.0 to 50.0 °C
HC12 OT deactivation value	15.0 °C	-50.0 to 50.0 °C
HC13 OT deactivation value	15.0 °C	-50.0 to 50.0 °C

Tag-Sollwerte	
HK1 Raumtemp.	20.0°C
TwW Trinkwassert.	60.0°C
HK1 AT Abschaltt.	22.0°C

Turn the rotary switch to  $\downarrow$ \* (day set point) or  $\downarrow$ C (night set point). The day and night set points appear on the display one after the other.

➔ Only those day and night set points are available for selection which can be controlled by the selected system.

**i Note**

The deactivation values are located in a separate menu (deactivation values) for systems with three control circuits.

Night set points	
HC1 Room temp.	15.0°C
DHW DHW temp.	40.0°C
HC1 OT deac. da	15.0°C

⌂ Select the set point.

\* Activate editing mode for set point.

⌂ Adjust the set point.

\* Confirm setting.

Proceed in the same manner to adjust further set points.

**After adjusting all the set points:**

Turn the rotary switch back to  $\square$  (operating level).

## 8.4 Reset to default settings

All parameters set over the rotary switch as well as parameters in the PA1, PA2, PA3, PA11, PA12 and PA13 parameter levels can be reset to their default settings (WE). This does not apply to the maximum flow temperature and the return flow temperature limits in PA1 and PA2.

Key number
<b>1991</b>

Turn the rotary switch to  $\diamond$  (settings).

⌂ Enter key number 1991.

\* Confirm key number.

The settings are reset to default when the following icon appears on the controller display:



## Operation

### 8.5 Reading information

Different kinds of information can read off the controller display during operation. The controller display usually shows the date, time and an actual temperature when the rotary switch is switched to the 'Operating level' position.

#### Outdoor-temperature-compensated control · Current temperature = outdoor temperature



Deactivation depending on outdoor temperature active)



Vacations active

#### Fixed set point control · Current temperature = Flow temperature



Further information can be obtained by turning the rotary pushbutton:

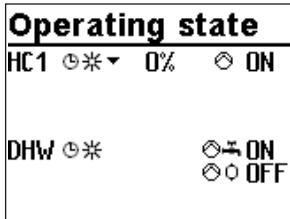

Operating state

The following applies for heating circuits HC1, HC2, HC3, HC11, HC12 and HC13:

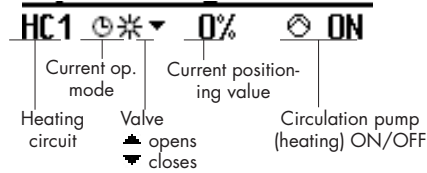

The following applies for DHW heating:

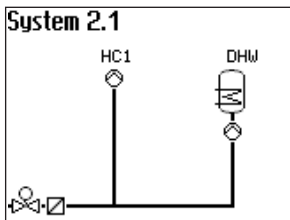
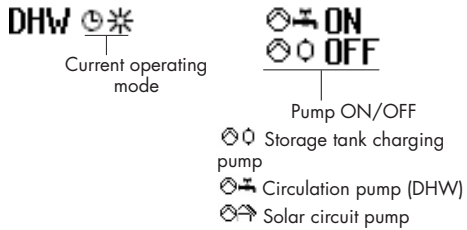

Selected system code number

- \* Key measured values for the entire system, e.g. measured values and limits of a flow rate or capacity limitation, if activated.

## Operation

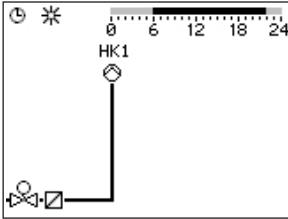

- ⌚ Times-of-use (depending on the system code number)
  - Heating circuit HC1
  - Heating circuit HC2
  - Heating circuit HC3
  - Heating circuit HC11
  - Heating circuit HC12
  - Heating circuit HC13
  - DHW heating

The day mode times is highlighted in black on the time chart.

Night mode and deactivation times are highlighted in gray on the time chart.

### Special values

Measured v. 13	0.0
Measured v. 2	9.8
Measured v. 3	45.8
Measured v. 8	44.7
Measured v. 9	61.2

- ⌚ Special values  
Measured values from additional sensor inputs (not relevant to closed-loop control) or from the 0 to 10 V inputs are displayed.

### Alarm list

15:45 Sensor failure  
28.10. Start with defaults

14.12.2021 15:45 - Failed

- ⌚ Alarm list  
The last four alarm entries are listed.
- \* Open the alarm list and select further alarm entries (⌚). Further information on an alarm (including time and date when it occurred) runs across the display.

### Event list

18:04 C05-F24=0  
18:01 System=4.1  
18:01 HC1 Automatic  
17:59 HC1 Stand-by

14.12.2021 18:04 - Functio

- ⌚ Event list  
The last four event entries are listed.
- \* Open the event list and select further event entries (⌚). Further information on an event (including time and date when it occurred) runs across the display.



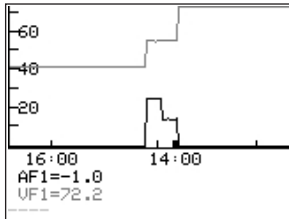

- ⌚ Trend-Viewer  
The standard graph shows the data measured at the outdoor sensor AF1 and flow sensor VF1 plotted over time.

### Extended operating level

Information	
Modbus ID	5578
Serial number	4378
Software version	2.50
Hardware version	1.75

The following details on the controller version (device identification, serial number, software and hardware versions) and meter bus are displayed in the extended operating level.

Information		p.1/3
Modbus station	255	
Logging memory	OFF	
Solar operation	0 h	
Flow rate 1	0	
Special flags	3840	

- Turn the rotary switch to ↻ (settings).
- ⌚ Enter code number 1999.
- \* Confirm key number.  
Turn the rotary switch to 🗄 (operating level).
- ⌚ Select 'Information'.

Information		p.2/3
VF 1-Rüf 1	--.°C	
Y1 avg mth bfr lst	10240	
Y1 avg last month	0	
Y1 avg this month	0	
Binary inputs	□ □ □ □ □ □ □ □	

The additional "meter" page is displayed with connection status and further meter data for meters 1 to 3 in the "extended operating level" mode when the meter bus is activated (see Annex A). In addition, the respective measuring and limit values are displayed after confirming the plant scheme when the flow rate and/or capacity limitation is active.

## Operation

Information	p.3/3
Reason for reset	SW

### **i** Note

- The additional information is hidden when the key number 1999 is entered again.
- The key number 1999 cannot be used to change the controller configuration and parameterization. A separate key number exists for configuration and parameterization (see the 'Start-up' section).

## 8.5.1 Adapting the Trend-Viewer

The standard graph shows the data measured at the outdoor sensor AF1 and flow sensor VF1 plotted over time.

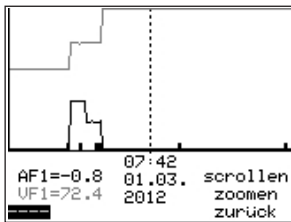

- \* Open the Trend-Viewer.

### **Adding measuring data**

- ⌚ Select ---- on the display.
- \* Activate editing mode for sensor selection.
- ⌚ Select sensor.

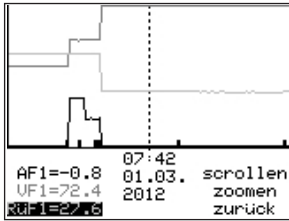

- \* Confirm setting.

### Deleting measured data:

- ⌚ Select the sensor whose measured data are no longer to be displayed.
- \* Activate editing mode for sensor.
- ⌚ Select - - - - on the display.
- \* Confirm deletion.

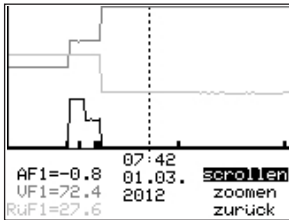

### Shifting the time line:

- ⌚ Select 'Scroll'.
- \* Activate editing mode for scroll function.

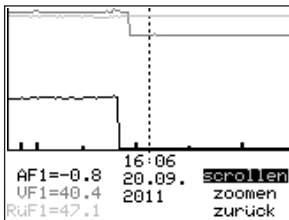

- ⌚ Shift the time line.
- \* Confirm time display.

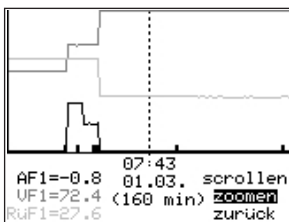

### Zooming in/out

- ⌚ Select 'Zoom'.
- \* Open zoom function.
- ⌚ Zoom in or out.

- \* Confirm display.

### Closing the Trend-Viewer

- ⌚ Select 'Back'.
- \* Close the Trend-Viewer

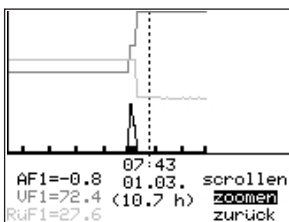

### 8.6 Operating the controller in manual mode

Switch to manual mode to configure all controller outputs.

#### NOTICE

System damage caused by frost when manual operating mode is active!

The frost protection function is deactivated in the manual operating mode.

→ Do not run the heating during cold weather in the manual mode for long periods of time.

Manually changing the positioning value/switching state:

Handbetrieb			
HK1		▼	0%
HK1			EIN
TWW			EIN
TWW			AUS
Informationen			

Turn the rotary switch to (manual mode). The outputs of the configured system are listed on the display.

- ① Select the output
  - Positioning value
  - Circulation pump (heating)
  - Storage tank charging pump
  - Circulation pump (DHW)
  - Solar circuit pump
- ② Activate editing mode for the output.
- ③ Change the positioning value/switching state.
- ④ Confirm the positioning value/switching state.  
The modified values remain active as long as the controller is in manual mode.

Turn the rotary switch to (operating level). The manual mode is deactivated.

#### Note

The outputs of the controller are not affected by merely turning the rotary switch to (manual mode). The outputs are only changed by entering or changing the positioning values or switching states.

## 9 Error list

Sensor failure	= Sensor failure (see the 'Malfunctions' section in the Mounting and Operating Instructions ► EQJW246F003)
Disinfection	= Disinfection temperature not reached. See 'Thermal disinfection of DHW storage tank' function in Annex A (configuration instructions) of the Mounting and Operating Instructions ► EQJW246F003.
Max. charging temp.	= Max. charging temperature reached. See 'DHW heating in the storage tank charging system' function in Annex A (configuration instructions) of the Mounting and Operating Instructions ► EQJW246F003.
External	= Error message from device bus
Temp. monitoring	= Temperature monitor alarm
Unauthorized access	= Unauthorized access occurred (see the 'Malfunctions' section in the Mounting and Operating Instructions ► EQJW246F003)
Binary alarm	= Error message of a binary input
Meter bus	= Meter bus communication error

## Technical data

# 10 Technical data

Inputs	14x sensor inputs Pt 1000, PTC or Ni 1000, alternatively configurable for binary signals 3x inputs for 0 to 10 V Input 17 for a 3 to 800 lmp/h pulse signal from a heat meter meter for power limitation in HC1 configurable
Outputs	3x three-point signal, alternatively 3x two-point signal: HC1, HC2: Relay outputs, max. load 250 V AC, 2 A; HC3: Triac output, load capacity max. 250 V AC, 0.12 A 5x pump output: relay outputs, max. load 250 V AC, 2 A All relay outputs with varistor suppression 4x 0 to 10 V or PWM signal, configurable, for control signal output or speed control of pumps, load >5 kΩ
Interfaces	Ethernet interface for Modbus TCP/IP communication and connection to building automation via Internet router. Alternative access options via optional external gateways M-Bus interface for up to three M-Bus devices, protocol in accordance with EN 1434-3
	Galvanically isolated RS-485 interface for Modbus RTU and device bus communication. Modbus RTU data format: 8N1 Bluetooth® interface 4.1
Ambient temperature	0 to 40 °C (operation), -10 to 60 °C (storage and transport)
Degree of protection	IP 40 according to IEC 529
Class of protection	II according to VDE 0106
Degree of contamination	2 according to VDE 0110
Overvoltage category	II according to EN 60664
Noise immunity	According to EN 61000-6-1
Noise emission	According to EN 61000-6-3
Compliance	
Weight	Approx. 0.5 kg



**EQJW246F003**



**SAUTER Deutschland**

Sauter-Cumulus GmbH

Hans-Bunte-Str. 15

79108 Freiburg

<http://www.sauter-cumulus.de>

Telefon +49 (761) 5105-0

Telefax +49 (761) 5105-234

E-Mail: [sauter-cumulus@de.sauter-bc.com](mailto:sauter-cumulus@de.sauter-bc.com)

D100523804 26.06.2024